

Semiconductor Fabrication Process

(반도체공정개론)

장소: 공과대학 6호관 510호

시간: 화 (1-A, 1-B, 2-A, 2-B, 3-A, 3-B)

Textbook

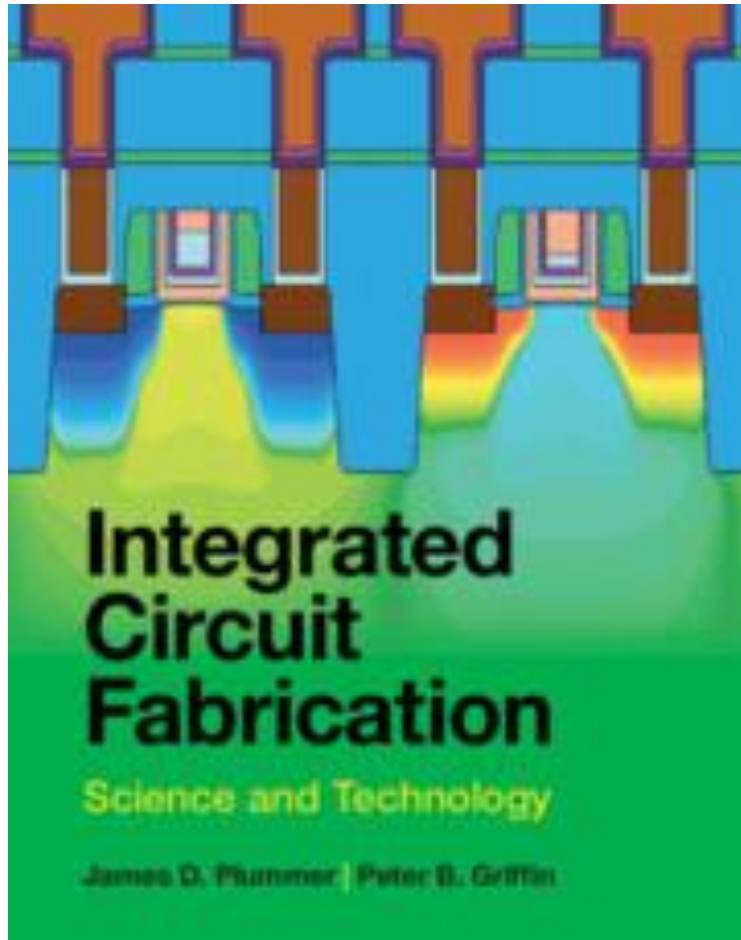

부교재: 다양한 반도체공정 관련 서적

Also read auxiliary textbooks related to
Integration of Semiconductor devices

Syllabus

Weekly Course Schedule

Calendar	Description	*Remarks
1st week (3/4)	Orientation	
2nd week (3/11)	Introduction to CMOS Technology	
3rd week (3/18)	Semiconductor Materials: Crystal Growth, Wafer Preparation and Material Properties	
4th week (3/25)	Semiconductor Manufacturing: Cleanrooms, Wafer Cleaning, Gettering and Chip Yield	
5th week (4/1)	Lithography I (Case study)	
6th week (4/8)	Semiconductor/Insulator Interfaces (Case study)	
7th week (4/15)	Etching Technologies I (Case study)	
8th week (4/22)	Mid-Term Exam	
9th week (4/29)	Deposition Technologies I (Case study)	
10th week (5/6)	No Class	National Holiday
11th week (5/13)	Design and Fabrication of semiconductor device with various dimension and platform (Case study)	Conference
12th week (5/20)	Design and Fabrication of semiconductor device with various dimension and platform (Case study)	
13th week (5/27)	No Class	Conference
14th week (6/3)	No Class	Conference
15th week (6/10)	Design and Fabrication of semiconductor device with various dimension and platform (Case study)	
16th week (6/17)	Final Exam	

Grade

<평가방법 (How to grade)>

절대/상대평가 (Absolute/Relative)

<비중 (Portion)>

1. 중간고사 (Mid-Term Exam): 45%
2. 기말고사 (Final Exam): 45%
3. 출석평가* (Attendance *): 10%

1. Basic of Semiconductor

Why should we study semiconductor devices?

1. Basic of Semiconductor

Core subject to understand Semiconductor

1. General Chemistry
2. Physics
3. Materials Science and Engineering
4. Semiconductor Physics and Devices
5. Semiconductor Fabrication

The History of Semiconductor

Major Inventions Came with the Growth of Semiconductors

How have semiconductors contributed to the advances in electronics from the 20th century to the present day? The following multifaceted presentation traces the development of technologies that have enriched our lifestyle.

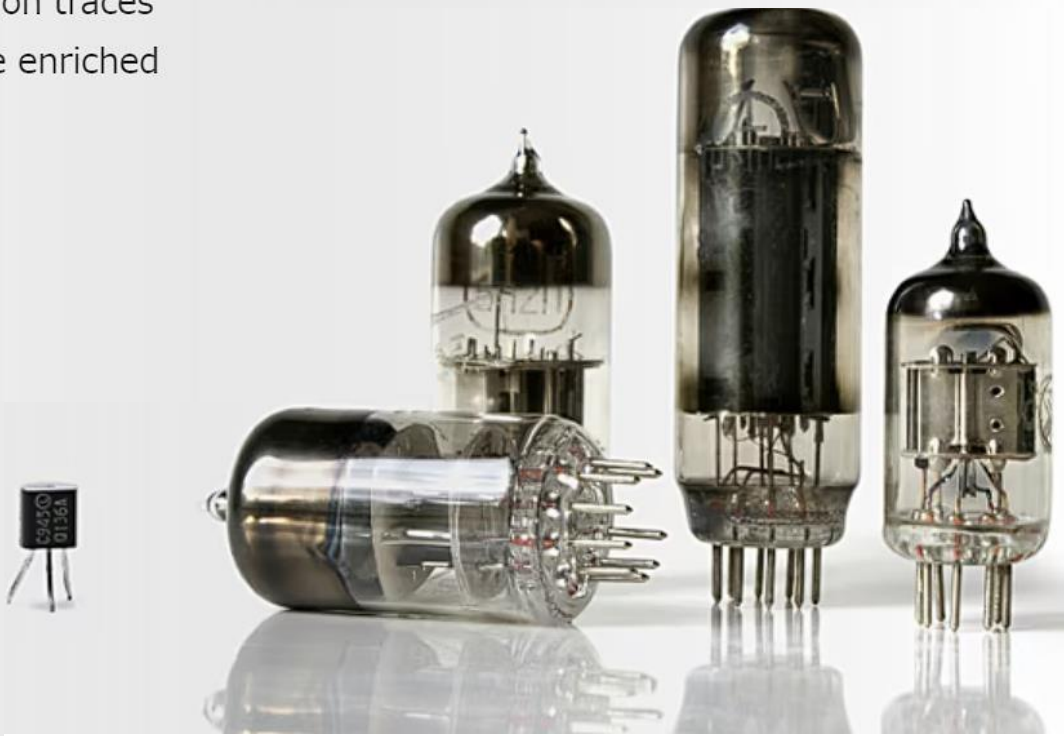

The History of Semiconductor

1904

1904: Two-electrode vacuum tube is invented

Thomas Alva Edison / John Ambrose Fleming

Thomas Alva Edison, the inventor of the first practical incandescent light bulb, had also noticed that the direct electric current flowed from a heated metal filament in the bulb to the other electrode only when the latter had a positive voltage. John Ambrose Fleming used this effect (known as the Edison effect) to invent the two-electrode vacuum tube rectifier, which was soon to play an important role in the electrical circuits.

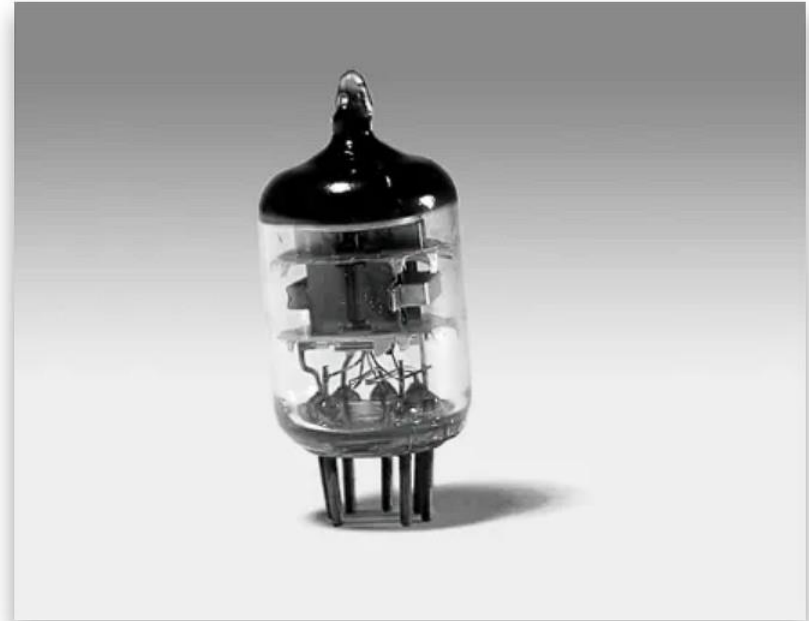

* The photo is for illustration purposes only

The History of Semiconductor

1946

1946: World's first general-purpose computer ENIAC is announced

ENIAC

ENIAC was the largest electronic machine ever made, equipped with some 18,000 vacuum tubes and weighing about 30 tons. It occupied a 160-square-meter room. The computer consisted of a total of about 110,000 electronic circuit devices.

In contrast, today's microprocessor typically integrates tens of millions of transistors and yet is smaller than the palm of your hand. This astonishing decrease in size started when solid state semiconductors replaced vacuum tubes.

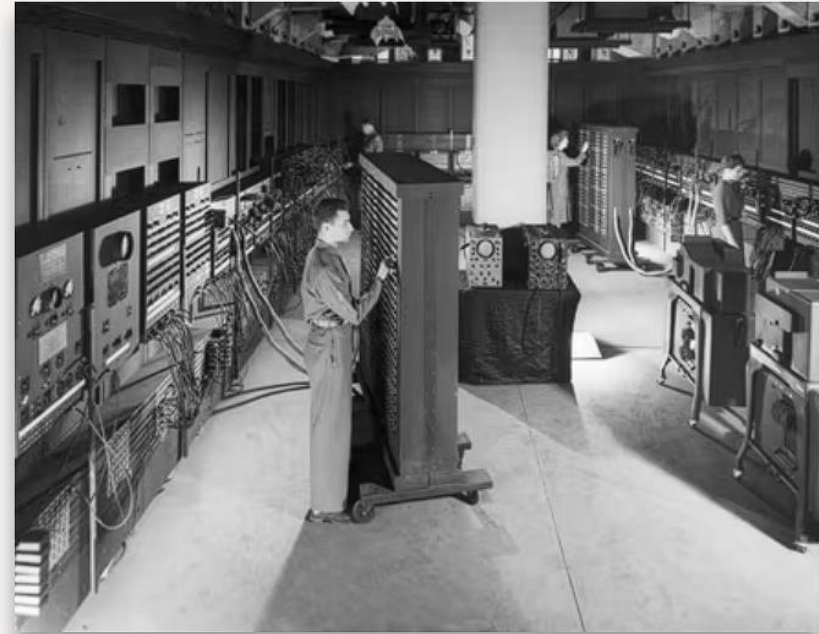

The History of Semiconductor

1948

1948: Junction-type transistor is invented

Transistor / William Bradford Shockley

Toward the end of 1947, John Bardeen and Walter Brattain at AT&T Bell Labs developed the point contact transistor, which was the first transistor ever constructed. William Shockley and his team continued with this research, and announced the invention of the mechanically solid junction-type transistor in June 1948.

Subsequently, integrated circuits (ICs) were invented that packed large numbers of transistors into a small chip, followed by large-scale integrated circuits (LSIs) with an integration level of 1,000-100,000 components or more on a chip.



* The photo is for illustration purposes only

The History of Semiconductor

1955

1955: Japan's first transistor radio is released

Transistor Radio / Sony

Early broadcast radio receivers used vacuum tubes. By replacing vacuum tubes with semiconductor transistor devices, radios became smaller, lighter, and less power consuming. Tokyo Tsushin Kogyo (Tokyo Telecommunications Engineering Corporation; now Sony) released Japan's first transistor radio TR-55 in 1955. While attempting to improve the yield of a transistor manufacturing process, the company's research team discovered the quantum mechanical effect known as tunneling.



* The photo is for illustration purposes only

The History of Semiconductor

1965

1965: Moore's law is announced

Gordon Moore

In 1965, Gordon Moore (who later became a co-founder of Intel) predicted that the integration rate of LSIs would double every 18 months, implying that it would quadruple in three years and become 1,000-fold denser in 15 years. The prediction, known as Moore's law, was based on the analysis of historical trends in the computer manufacturing industry. The proposition was widely accepted in the semiconductor and computer industries, and the reality turned out to be almost exactly as Moore had foreseen.

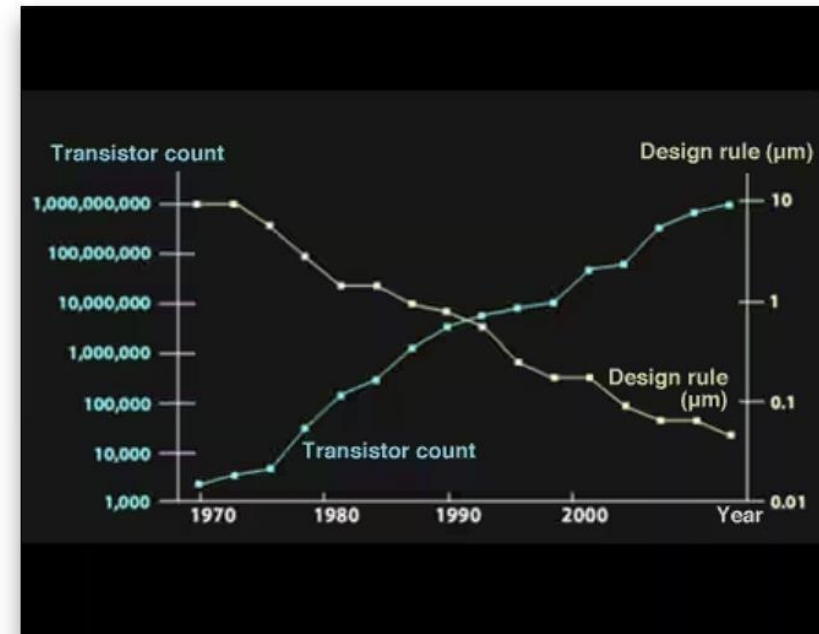

The History of Semiconductor

1971

1971: Intel 4004 is released

i4004 / Masatoshi Shima

Intel 4004 was the world's first single chip microprocessor. It was originally developed on the request of Busicom Corporation in Japan as an LSI for its electronic calculator. Intel's Ted Hoff proposed the idea of universal logic processor, which was taken up by Masatoshi Shima at Busicom and Federico Faggin at Intel who completed the chip design. Attracted by the potential versatility of this chip, Intel obtained the sales rights to the product.

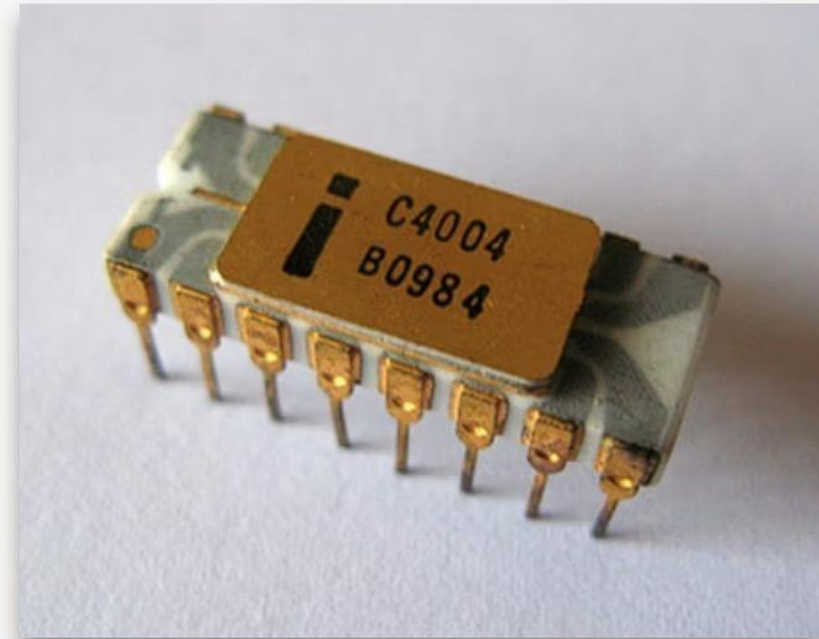

* Photo credit: Dentaku Museum

The History of Semiconductor

1977

1977: World's first personal computer Apple II is released

Personal Computer / Apple

Although many consider the Altair 8800 to be the world's first personal computer, its manufacturer called it a minicomputer along with other designations such as microcomputer and home computer. In contrast, Apple's Steve Jobs used the term "personal computer," which took hold with the commercial success of the Apple II.



* The photo is for illustration purposes only

The History of Semiconductor

1980

1980: Flash memory is invented

Flash Memory / Fujio Masuoka

Flash memory is a rewritable semiconductor memory device that is non-volatile (i.e., it retains the information when power is turned off). Unlike previous rewritable memory that could only erase the information one byte at a time, flash memory was designed to erase the entire block of data at once, and to reduce the cost per bit by 75% or more.

Flash memory was invented in 1980 by Fujio Masuoka (then a Toshiba employee). Today, flash memory is found in personal computers, mobile phones, digital cameras, IC cards, and many other applications that we use every day.

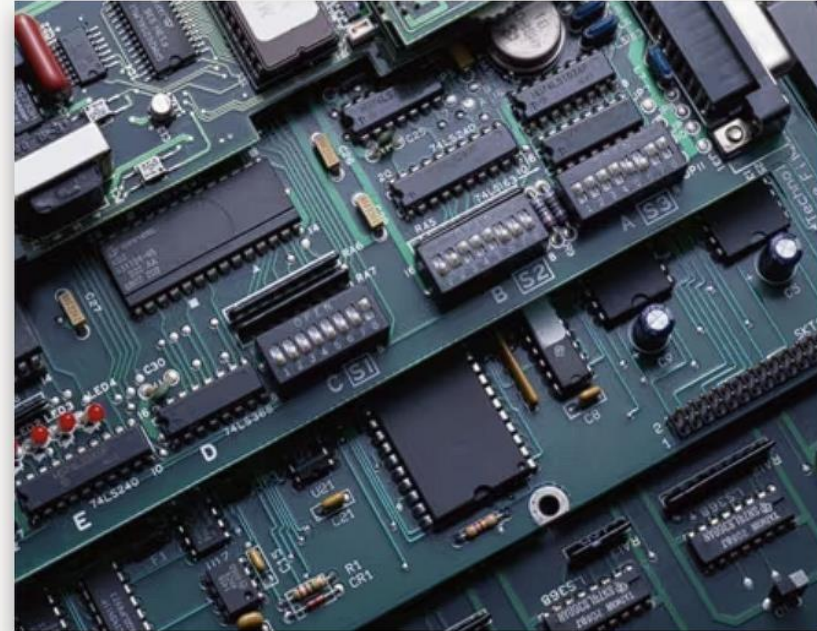

* The photo is for illustration purposes only

1. Basic of Semiconductor

Milestones of Silicon Semiconductor Industry

- 1947 : Invention of the **Ge transistor** at Bell Lab. (Bardeen, Brattain, Shockley)
- 1952 : Production of **ultra-pure Si and Ge** by zone refining technique at Bell Lab.
- 1955 : Invention of **diffusion-based transistor** at Bell Lab.
- 1958 : First demonstration of **integrated circuit** using mesa tech. at Texas Instruments.
- 1959 : Development of **IC using planar process** at Fairchild.
- 1959 : Invention of the **MOSFET** at Bell Lab.
- 1960's : Complete the planar process and IC fabrication process.
- 1970's ~ 80's : Market and technology development

First bipolar transistor

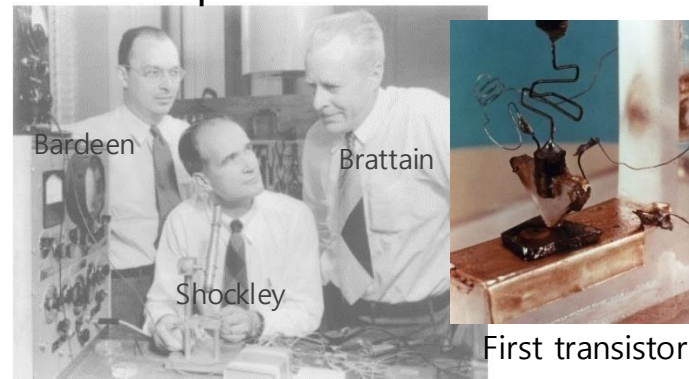

Nobel Prize (Physics) @1956

First integrated circuit

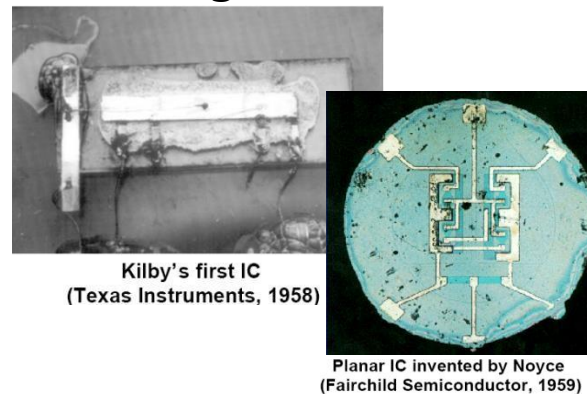

Nobel Prize (Physics) @2000

Microprocessor

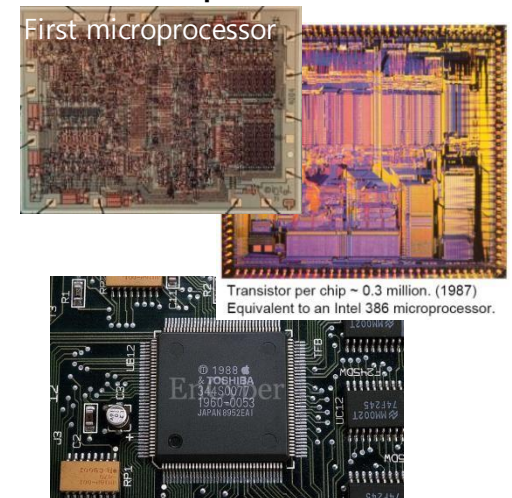

1. Basic of Semiconductor

What is semiconductor Technology ?

Semiconductor Technology

- Diode (p-n, Zener, Varactor diodes)
- Transistors (bipolar, field effect: MOS, MIS)

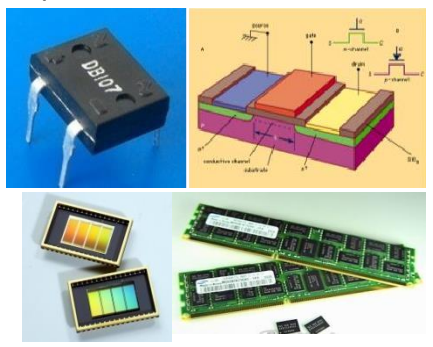

- Light-emitting diode
- Laser diode
- Photodiode
- Solar cell

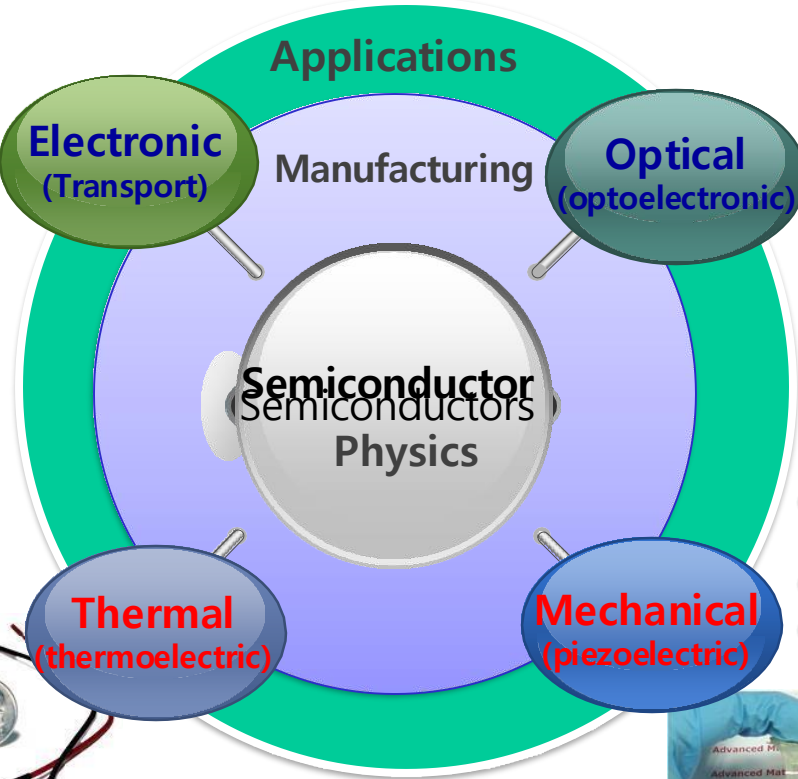
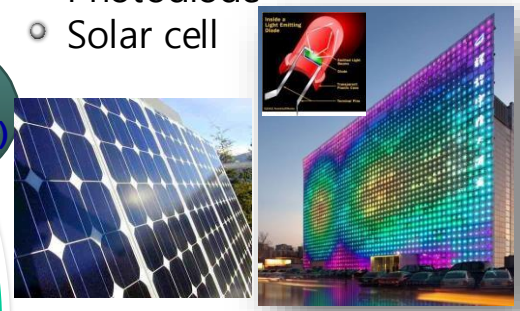

- Peltier thermal cooler
- Power generator (heat to electric power)

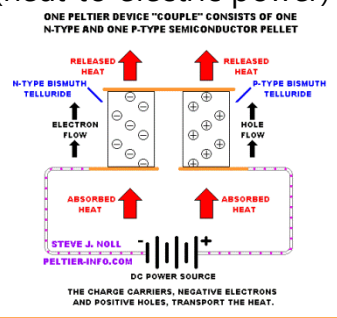

- Power generator (Mechanical to electric power)
- RF sensor
- Crash sensor

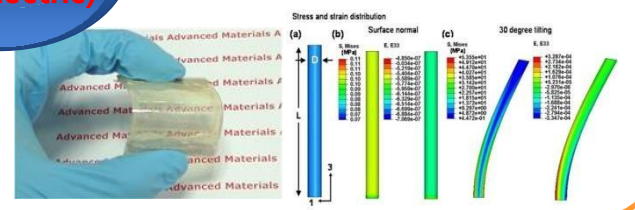

Study physics of semiconductors, devices and manufacturing methods.

1. Basic of Semiconductor

Why should we study semiconductor ?

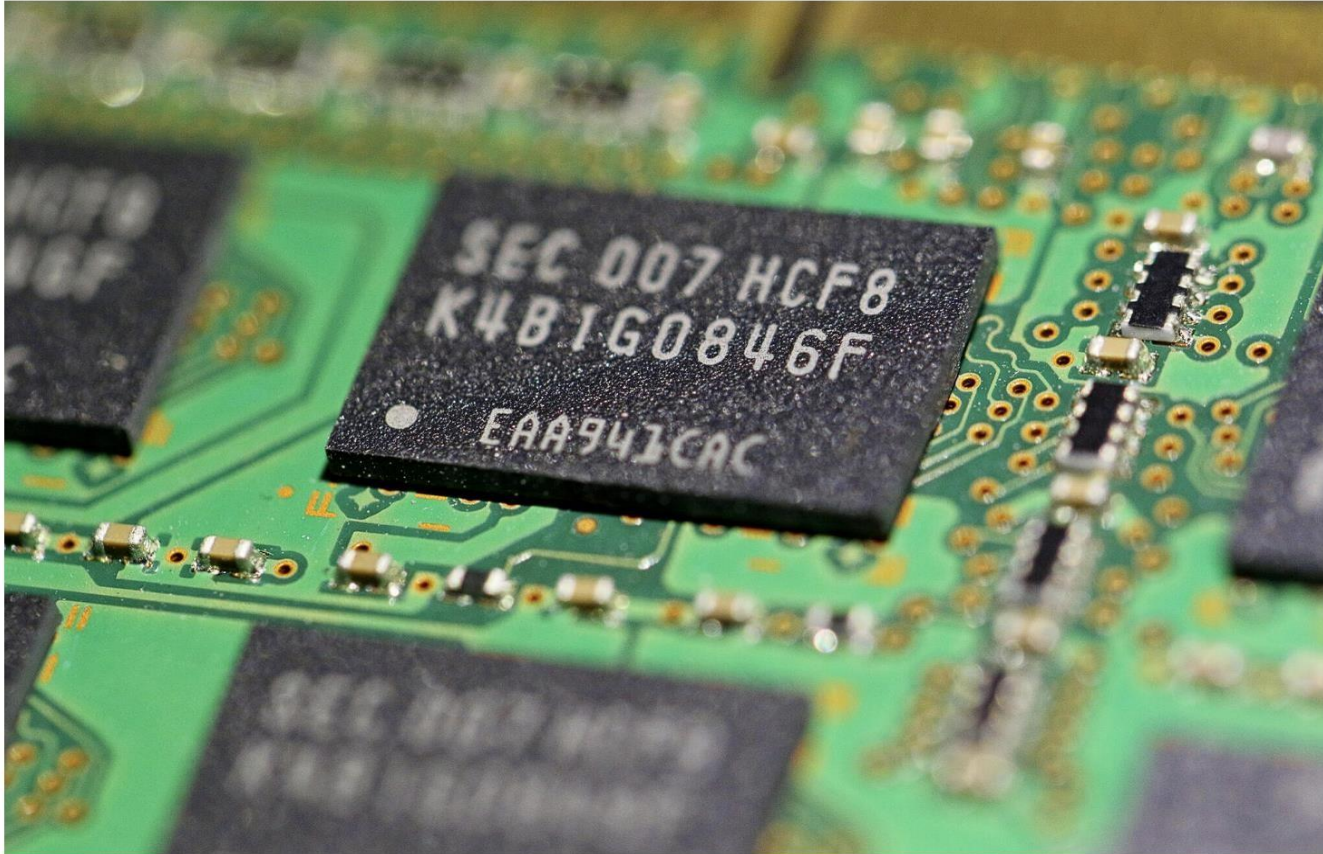

How South Korea's semiconductor industry may become the global leader by 2030

January 10, 2023 Korea market, South Korea

South Korea's semiconductor industry made up about **19.3%** of the global market, propelled by its memory market.

1. Basic of Semiconductor

Why should we study semiconductor ?

The semiconductor industry and its classification system

The semiconductor industry **can be classified** into four major groups: IDM, fabless, foundry, and OSAT. IDM (short for Integrated Device Manufacturer) companies **are responsible for the entire process of semiconductors**, from the planning to manufacturing and sales. Leading companies are Korean chaebols Samsung Group's **Samsung Electronics** (삼성 전자) and SK Group's **SK Hynix** (SK 하이닉스).

Whereas fabless companies like **Silicon Works** only design the semiconductors, the foundry companies like **DB HiTek** (**DB하이텍**) only manufacture them. OSAT (Outsourced Semiconductor Assembly and Test) companies like **HANA Micron** and **NEPES provide packaging and testing services**.

Classification	Characteristics	Major companies in South Korea	Major companies not in Korea
IDM	Companies that perform all production processes, including design, manufacturing, test, and packaging	Samsung Electronics SK hynix	Intel (USA)
Fabless	Companies that only design and develop without semiconductor manufacturing facilities	Silicon Works	Qualcomm (USA) Nvidia (USA) MediaTek (Taiwan)
Foundry	Companies that manufacture circuits on consignment, designed by fabless	DB HiTek	TSMC (Taiwan) GlobalFoundries (USA)
OSAT	Companies that assemble and test the finished wafers	HANA Micron NEPES	Amkor (USA) ASE (Taiwan)

1. Basic of Semiconductor

Why should we study semiconductor ?

Global Memory Semiconductor Market Share (2020)

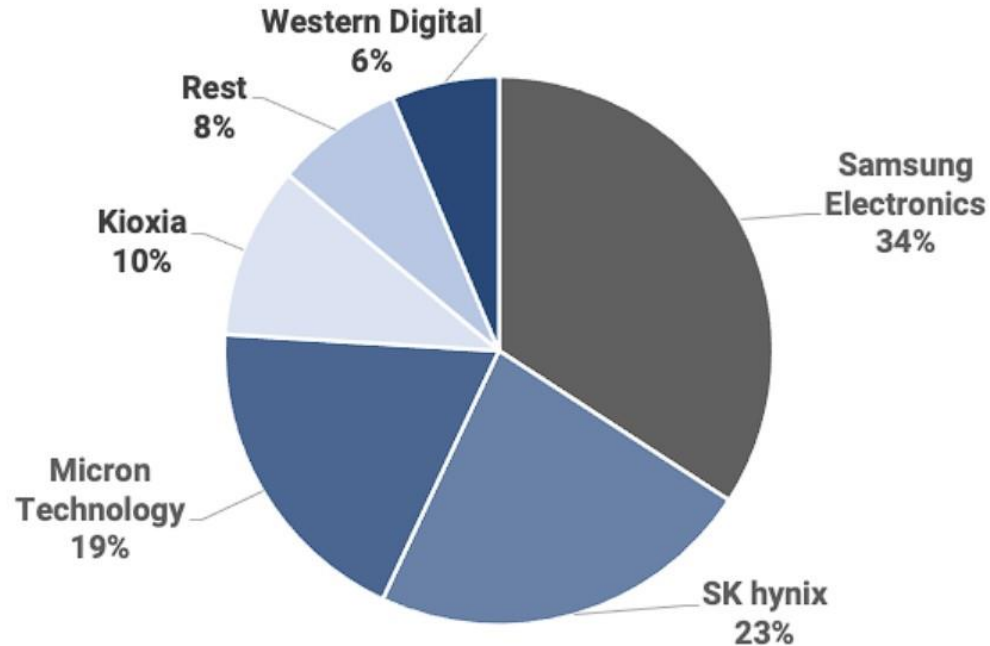

The logo for daxue consulting, featuring a stylized bar chart icon above the company name.

Source: Bloomberg (2022), modified and re-designed by daxue consulting, Chip-reliant economy with Korean chaebols Samsung Electronics and SK hynix of South Korea's semiconductor industry

Why should we study semiconductor?

Moore's Law (Functions per chip)

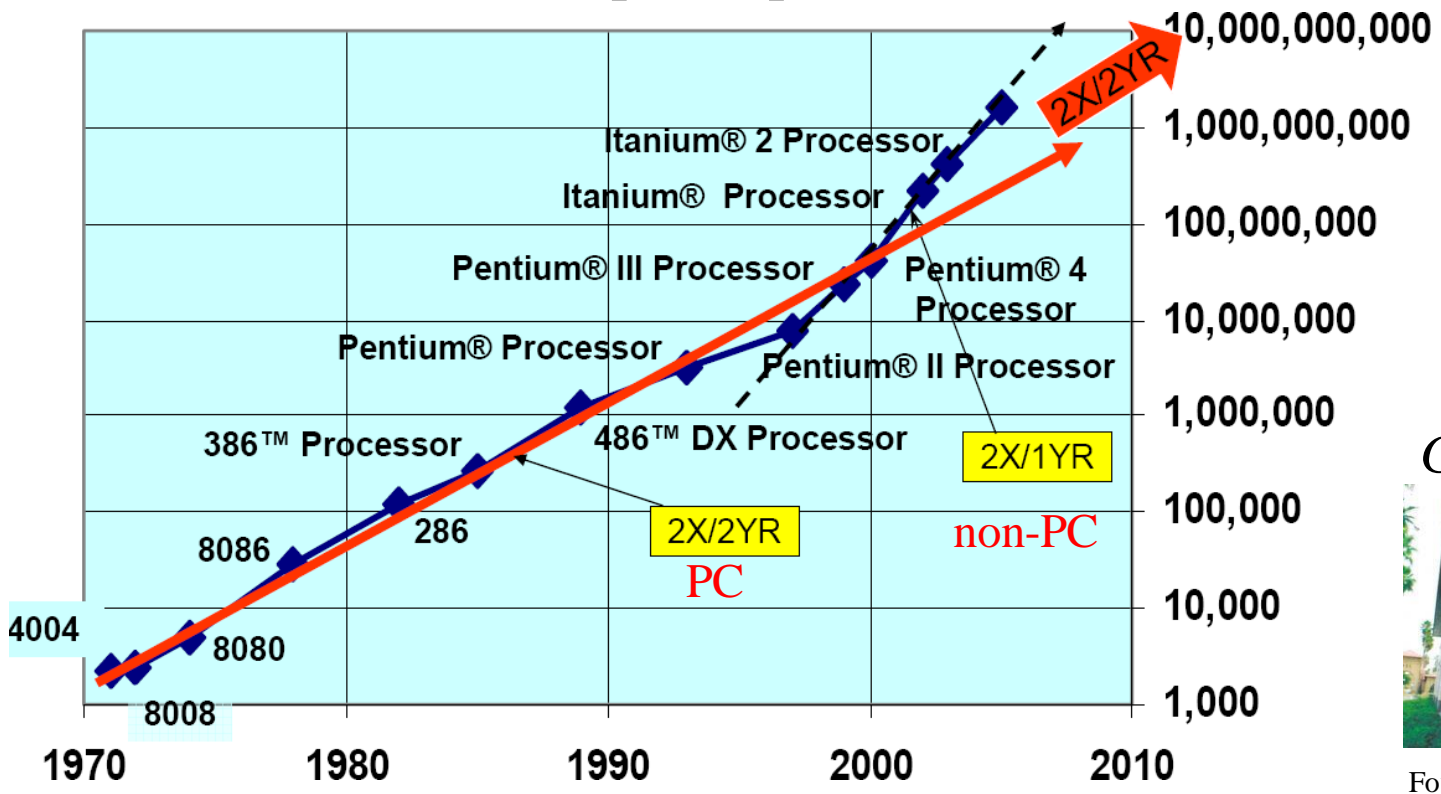

Gordon Moore

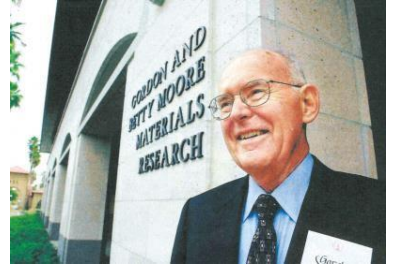

Founder and former CEO of Intel

The number of transistors that can be placed inexpensively on an integrated circuit has doubled approximately every two years.

➔ Development of semiconductor technology is getting more and more important !!

History of Silicon semiconductor industry

IC Development at Intel

Minimum Feature size reduction

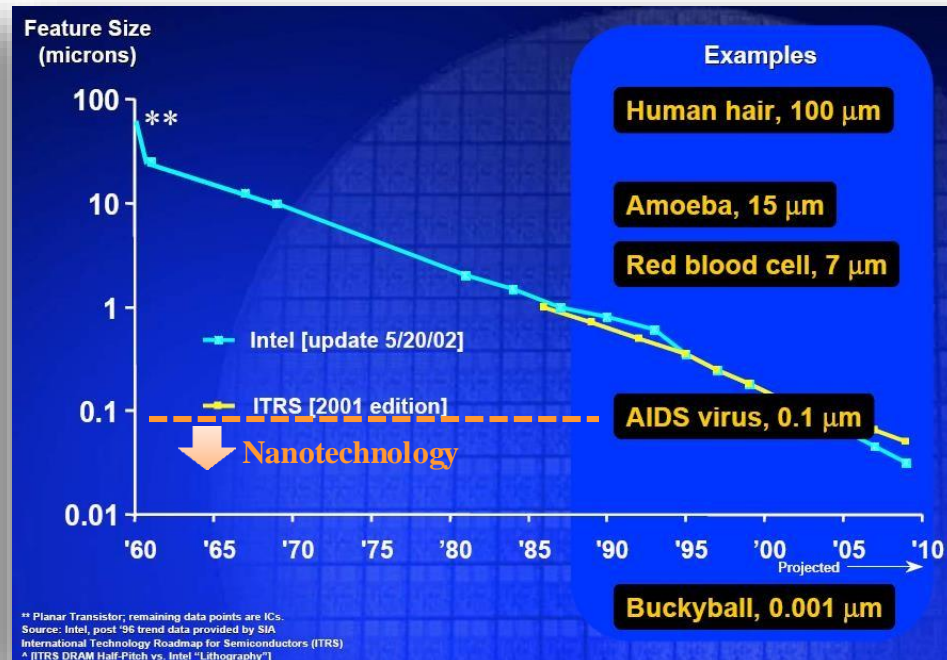
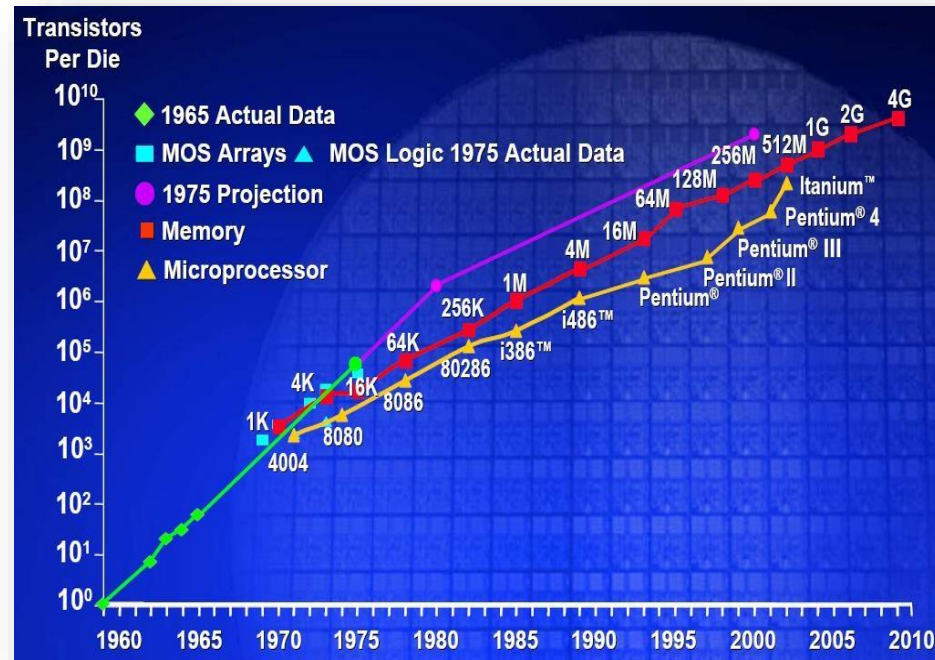

Source : Intel

Minimum feature size is the width of the smallest line or gap that appears in the IC design.

(depends on equipments and technology)

→ Indication of the technology development

→ **Development of semiconductor technology is getting more and more important !!**

Why should we study the Semiconductor?

Minimum feature size reduction with time

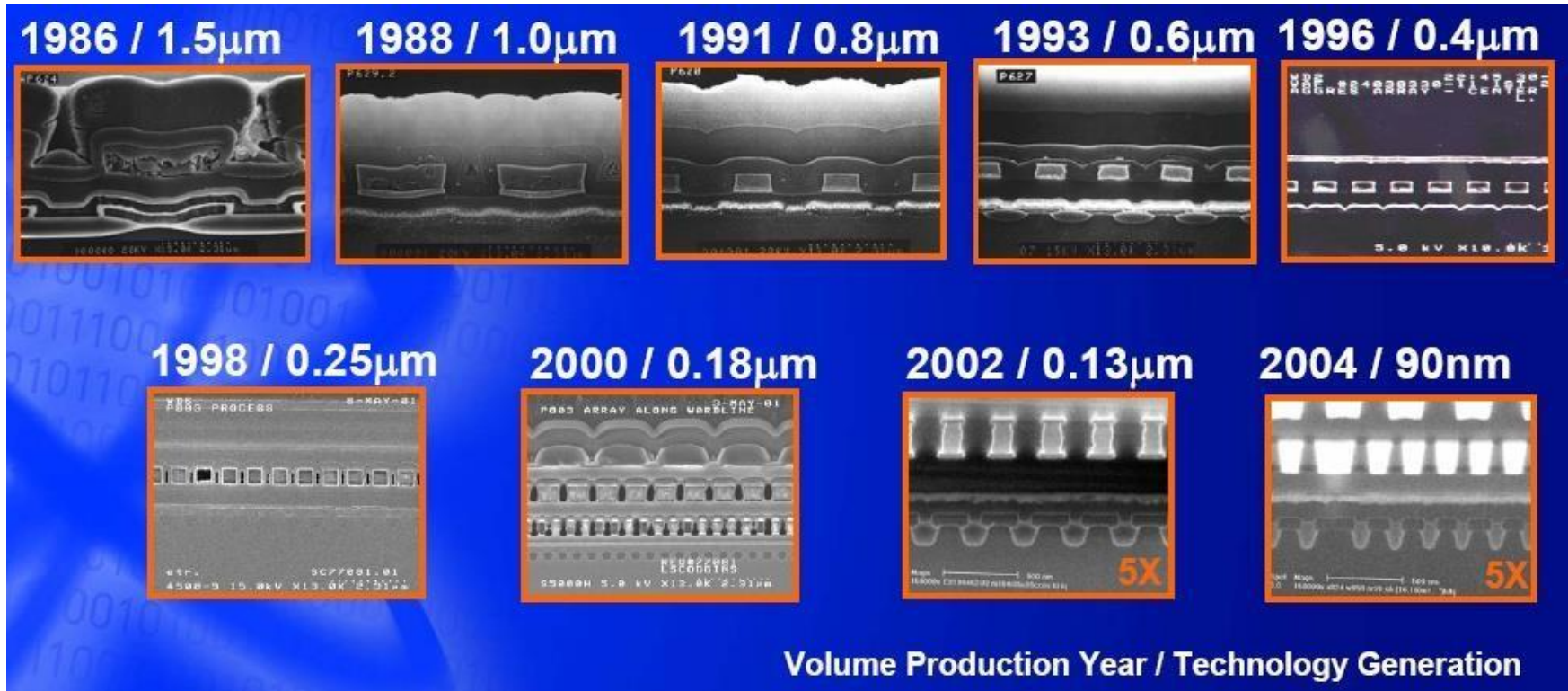

Today

- Flash / DRAM

Future

- Alternate memory : MRAM, FeRAM
- Nanoelectronics
- Optoelectronics
- Bioelectronics / Organic electronics

Understanding and development of new technology based on semiconductor engineering is required for electronic engineers !!

The incredible shrinking of the transistor !!

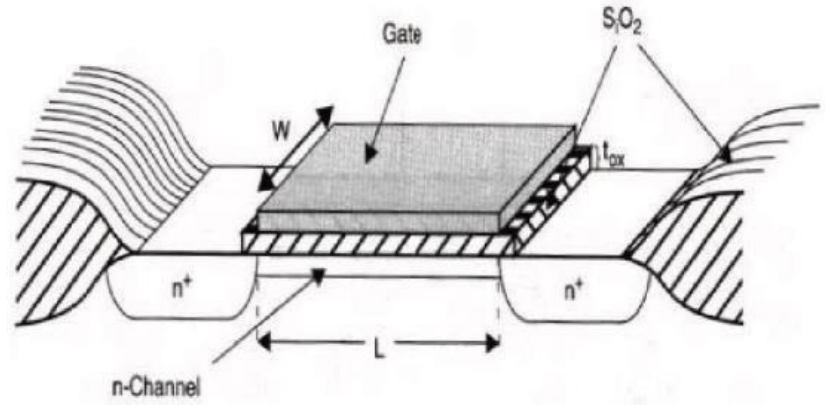
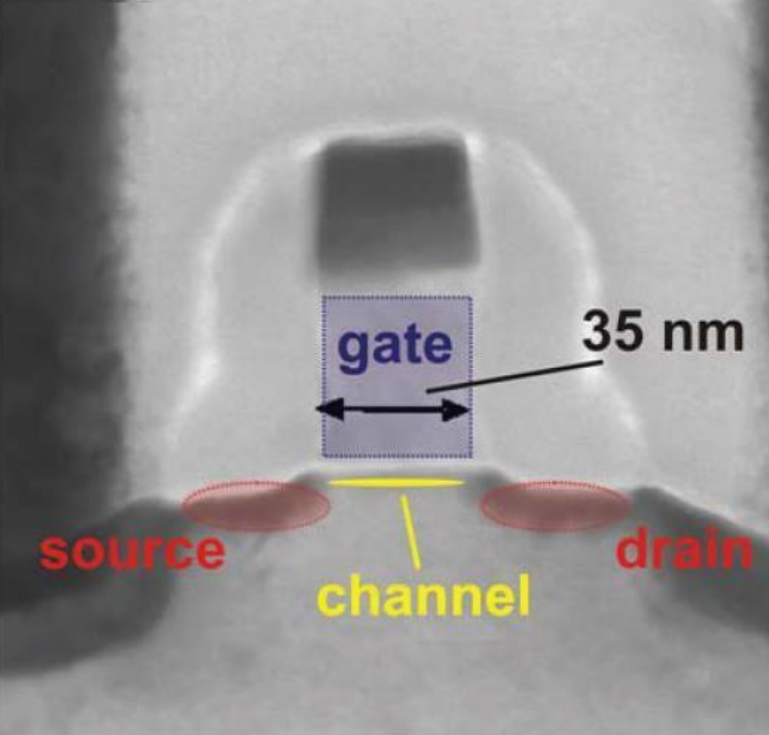

TEM image of a contemporary FET

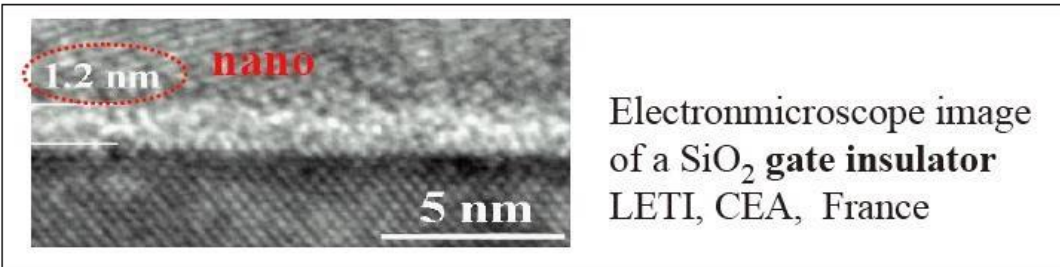
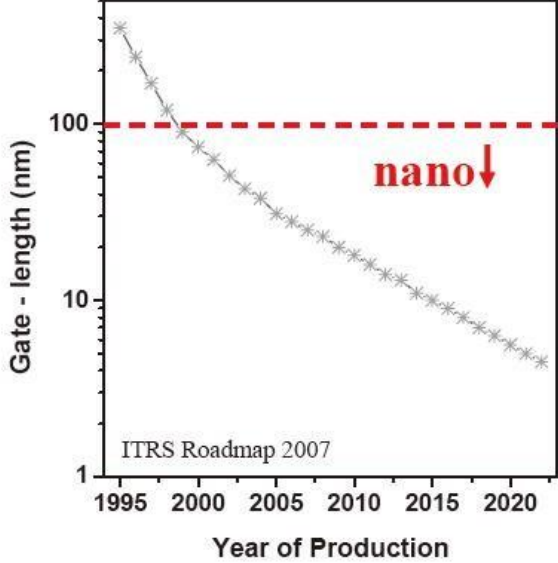

Electronmicroscope image of a SiO₂ gate insulator
LETI, CEA, France

The incredible shrinking of the transistor !!

Nanoelectronics and molecular electronics

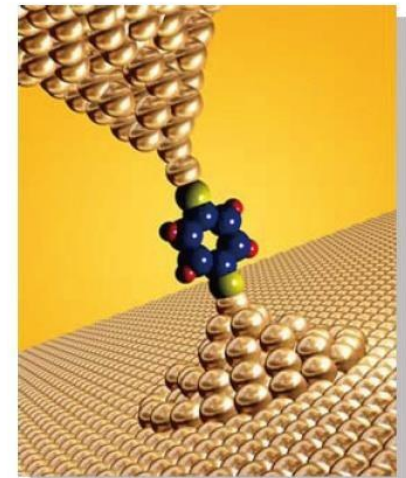
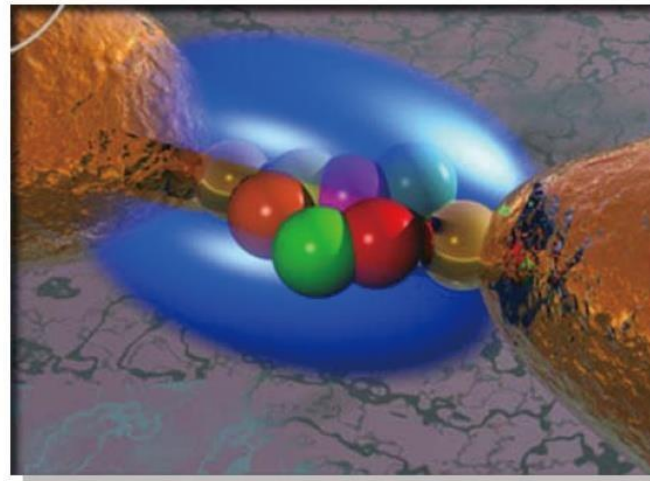
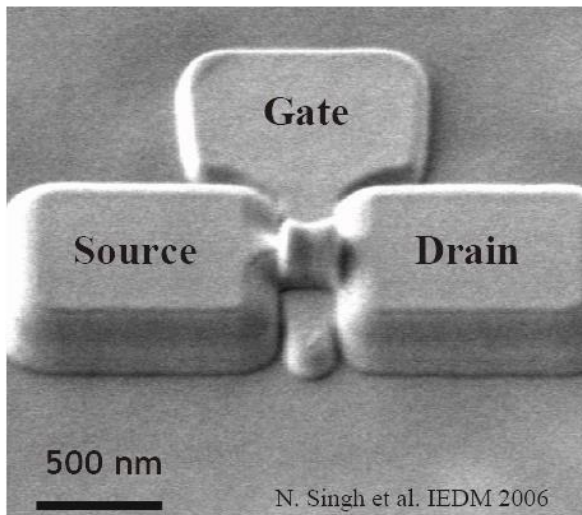
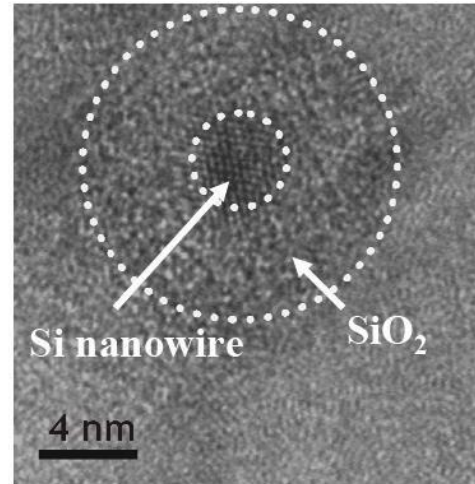
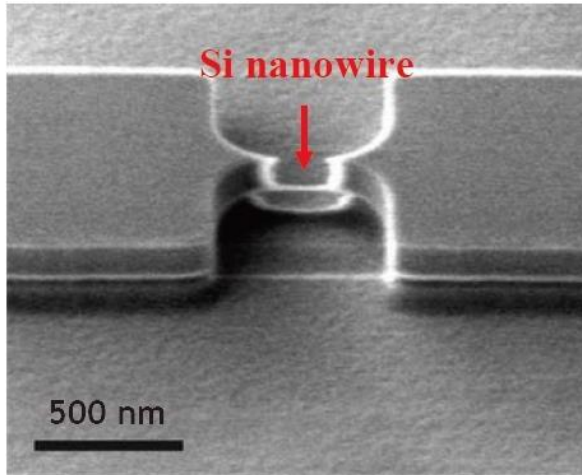

1. Basic of Semiconductor

So... What we are going to do?

Materials

What kind of materials are required?

Property

What kind of properties ?

Fabrication (Integration)

Let's made electronic device

Analysis

Electrical characteristics of the device

End of Slide